

Varenummer: 20343140M10KRE
Beskrivelse: E+G Justerfod
GN 343.1-40-M10-KRE

Mål

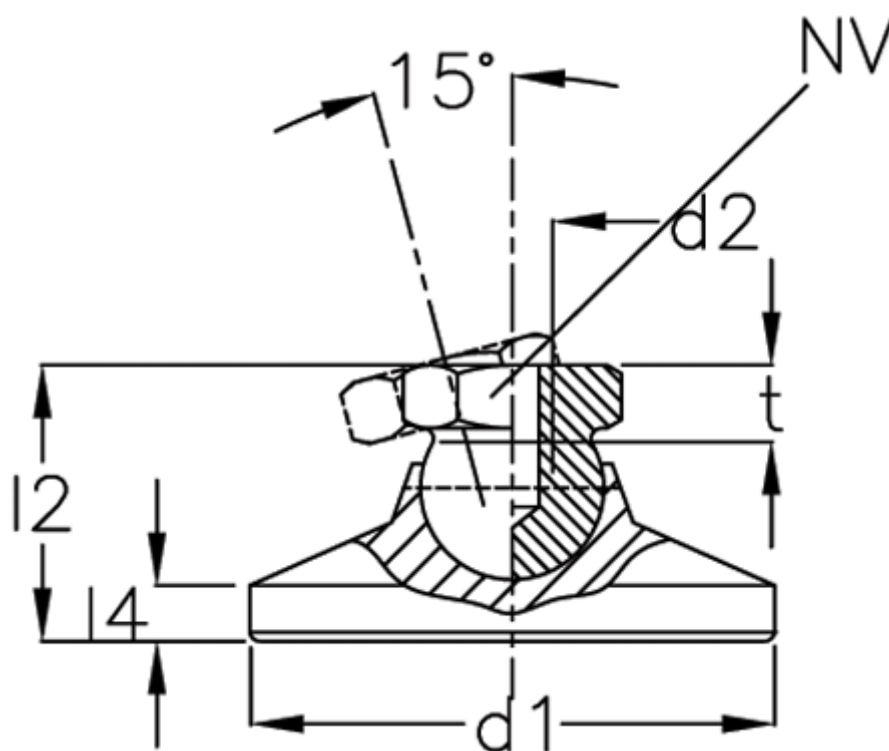

d1	= 40
d2	= 10
l2	= -
l4	= -
NV	= 15
Statisk belastning (kN)	= 20
t min	= 10.5